

在 Mac OS 以 USB 方式安裝及連接 PIXMA G4780 打印機

Installing PIXMA G4780 on Mac OS via USB connection

****注意: 安裝驅動程式前請勿接駁 USB 線，以免系統發生錯誤****

**** Please don't plug the USB cable until the driver asked to do so****

以下步驟及畫面僅供參考，實際操作畫面可能因裝置型號、系統或軟件版本而有所不同。

The following steps and screens are for reference only, and the actual operation screens may vary depending on the device model, system, or software version.

下載及安裝步驟

Driver download and Installation procedure

1. 到以下佳能網站並下載印表機的驅動程式
Go to below Canon webpage and download the printer driver
<https://hk.canon/en/support/pixma%20g4780/model>

2. 選擇並下載以下檔案
Choose and download below file

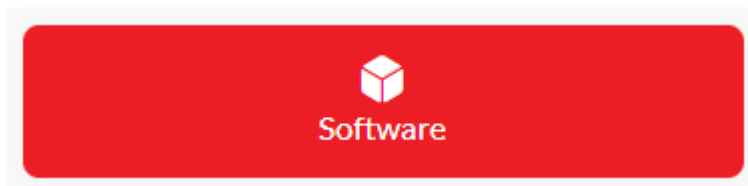

Master Setup (Mac)

<https://hk.canon/en/support/0200641904>

3. 按網頁內的 [Download]，下載完成後開啟該檔案安裝
Click [Download] in the webpage, and then execute the file after download was completed

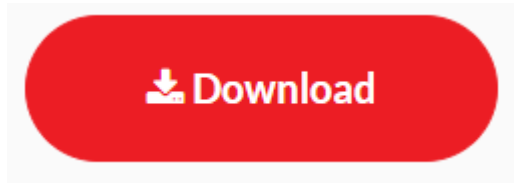

4. 按 [Master Setup]

Click [Master Setup]



5. 請輸入電腦帳號密碼，再按 [安裝輔助程式]

Please type in the password of computer account, then click [Install Helper]



6. 按〔開始設定〕
Press [Start Setup]



7. 請等候
Please wait



8. 按〔是〕
Click [Yes]



9. 閱後按〔同意〕或〔不同意〕
Click [Agree] or [Do not agree] after reading



10. 請等候
Please wait

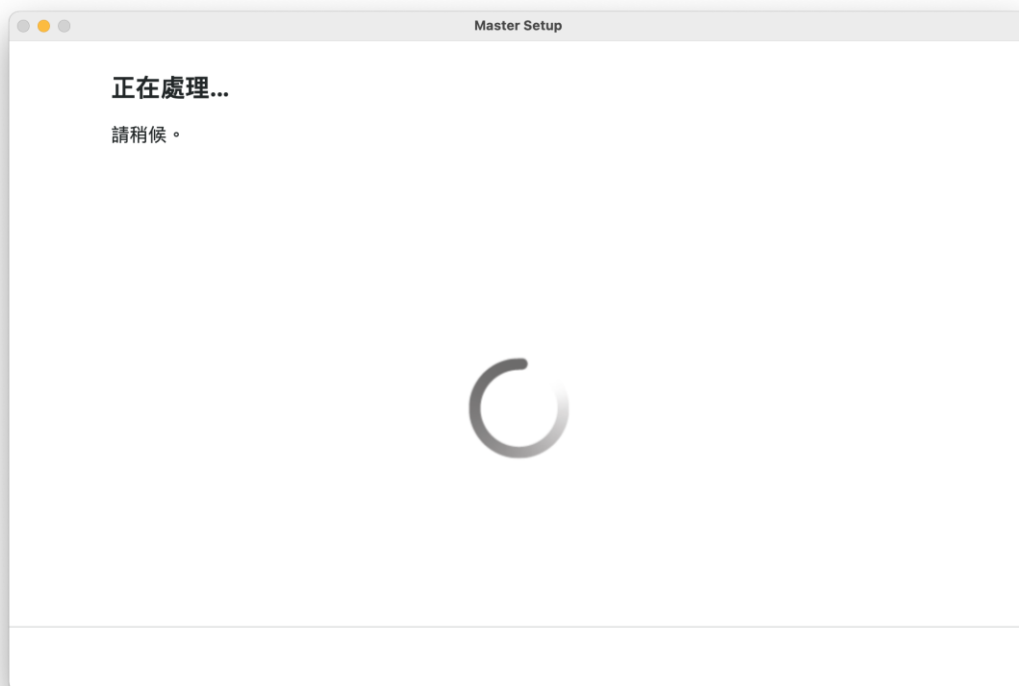

11. 確認印表機電源已開啟，再按〔下一步〕
Confirm power on the printer, then click [Next]



12. 請等候
Please wait

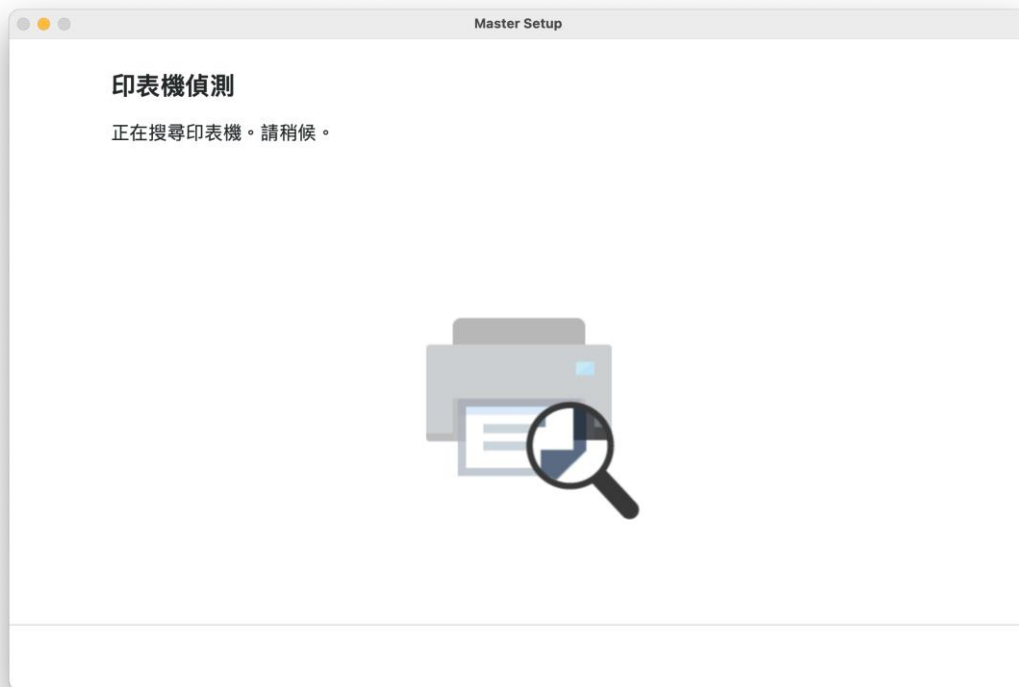

13. 選擇〔USB 連接(USB 電纜線)〕，再按〔下一步〕
Choose [USB Connection (USB Cable)], then click [Next]

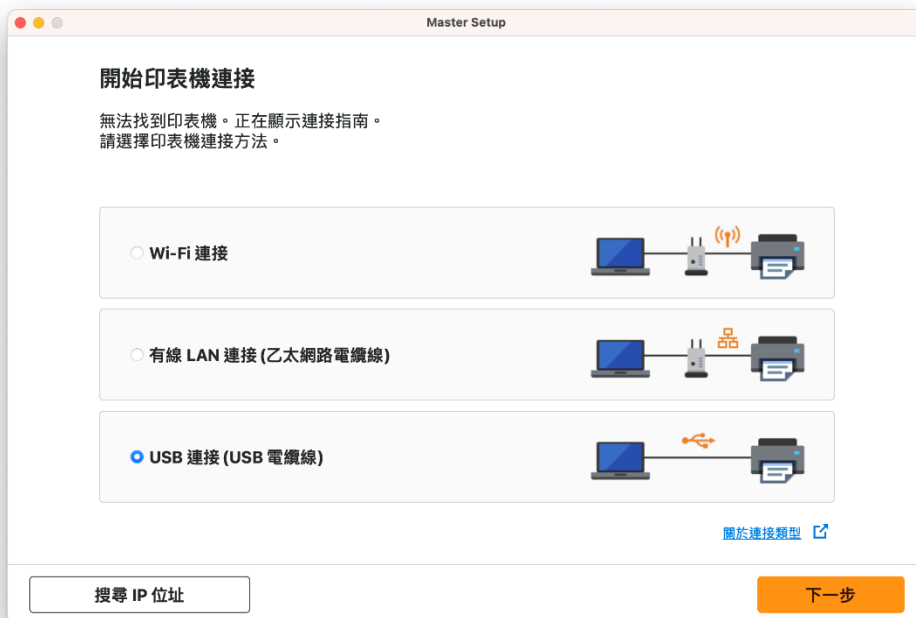

14. 使用 USB 電纜線連接打印機和電腦
Connect printer and computer with USB cable

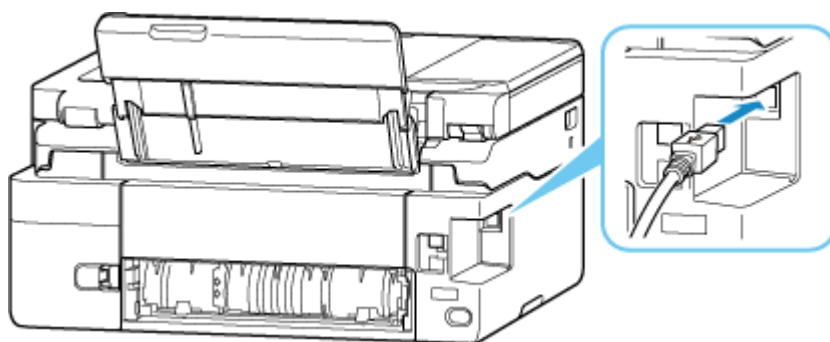
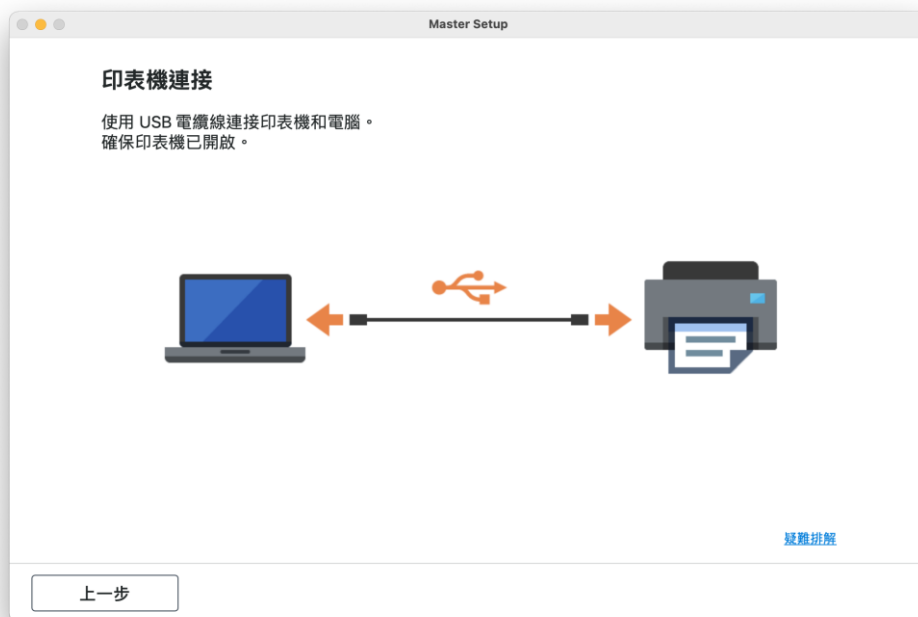

15. 請等候打印機偵測及軟件安裝

Please wait for the printer detection and software installation



16. 按〔下一步〕
Click [Next]

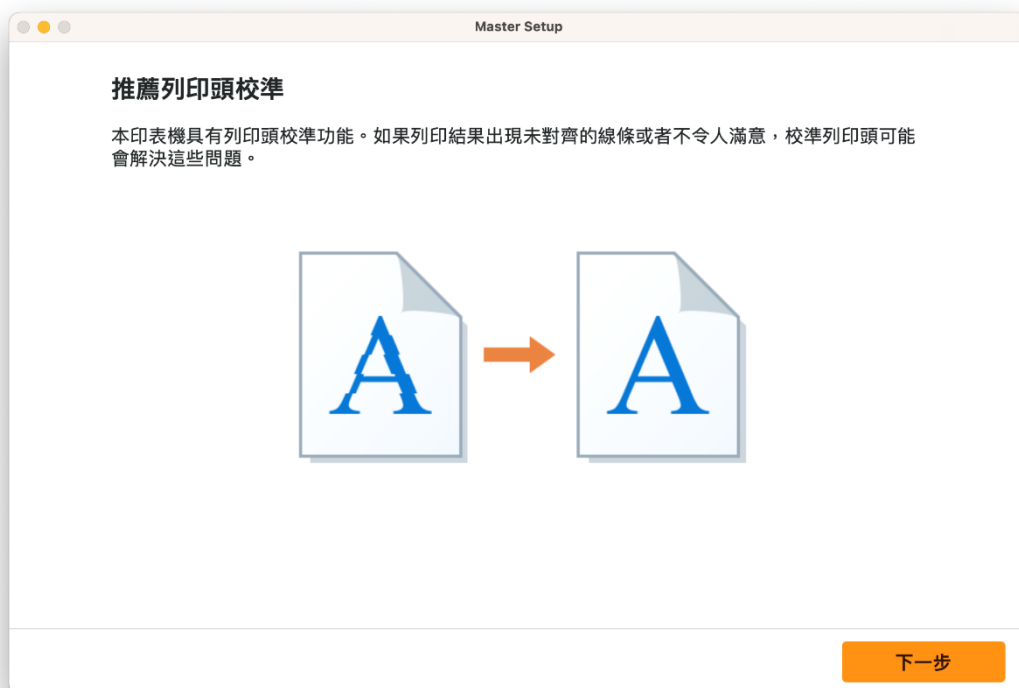

17. 按〔下一步〕
Click [Next]

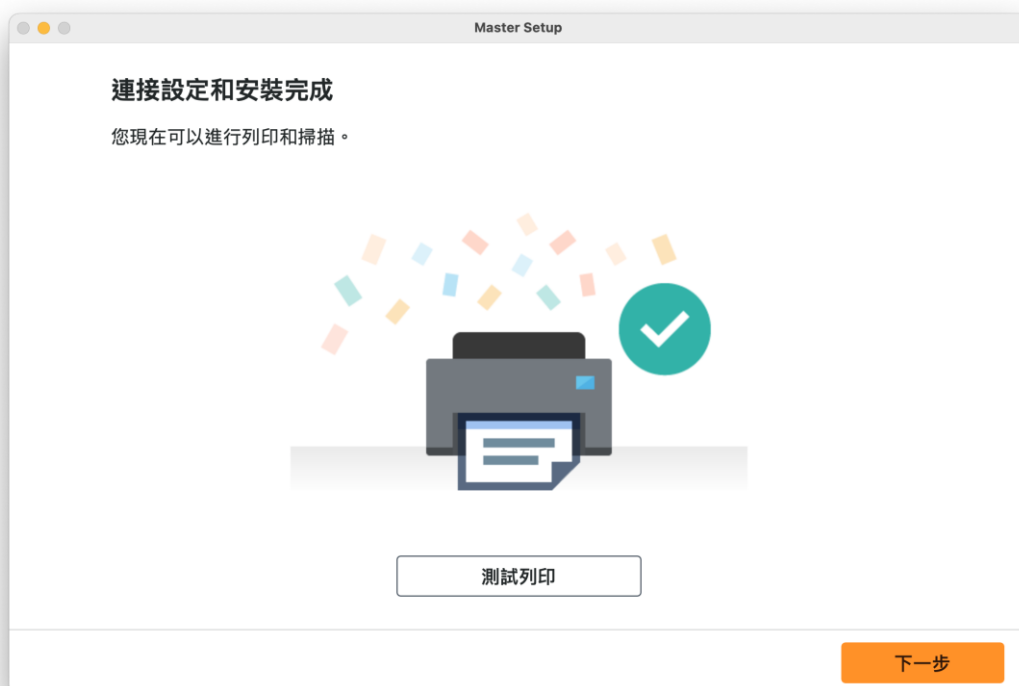

18. 安裝完成

Driver installation was completed



-完-

-End-