

在 Windows 以 USB 方式安裝及連接 PIXMA G3780 打印機

Installing PIXMA G3780 on Windows via USB connection

****注意: 安裝驅動程式前請勿接駁 USB 線，以免系統發生錯誤****

**** Please don't plug the USB cable until the driver asked to do so****

以下步驟及畫面僅供參考，實際操作畫面可能因裝置型號、系統或軟件版本而有所不同。

The following steps and screens are for reference only, and the actual operation screens may vary depending on the device model, system, or software version.

下載及安裝步驟

Driver download and Installation procedure

1. 到以下佳能網站並下載印表機的驅動程式
Go to below Canon webpage and download the printer driver
<https://hk.canon/en/support/PIXMA%20G3780/model>

2. 選擇並下載以下檔案
Choose and download below file
G3780 MP Driver Ver.x.xx (Windows)

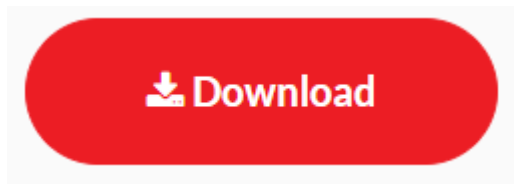

3. 按上面網頁內的 [Download]，下載完成後開啟該檔案安裝
Click [Download] in the webpage above, and then execute the file after download was completed

4. 按〔下一步〕

Click [Next]



5. 選擇〔亞洲〕，按〔下一步〕

Select [Asia]; click [Next]

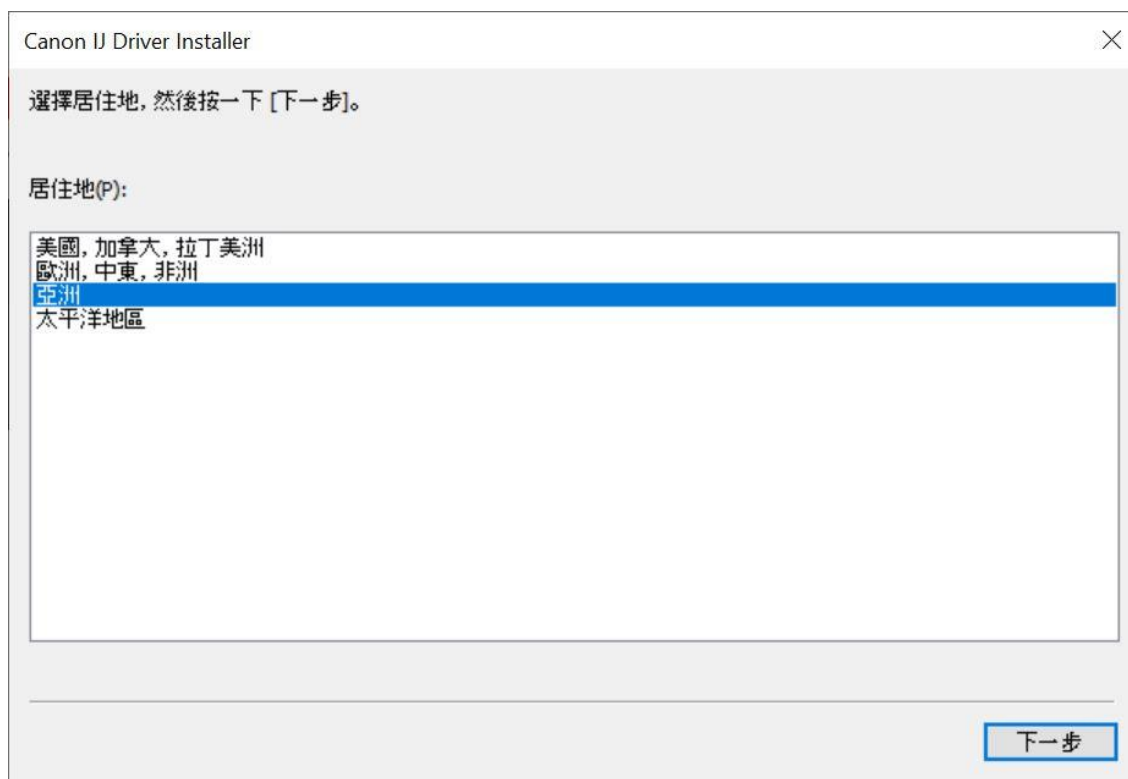

6. 按〔是〕
Click [Yes]

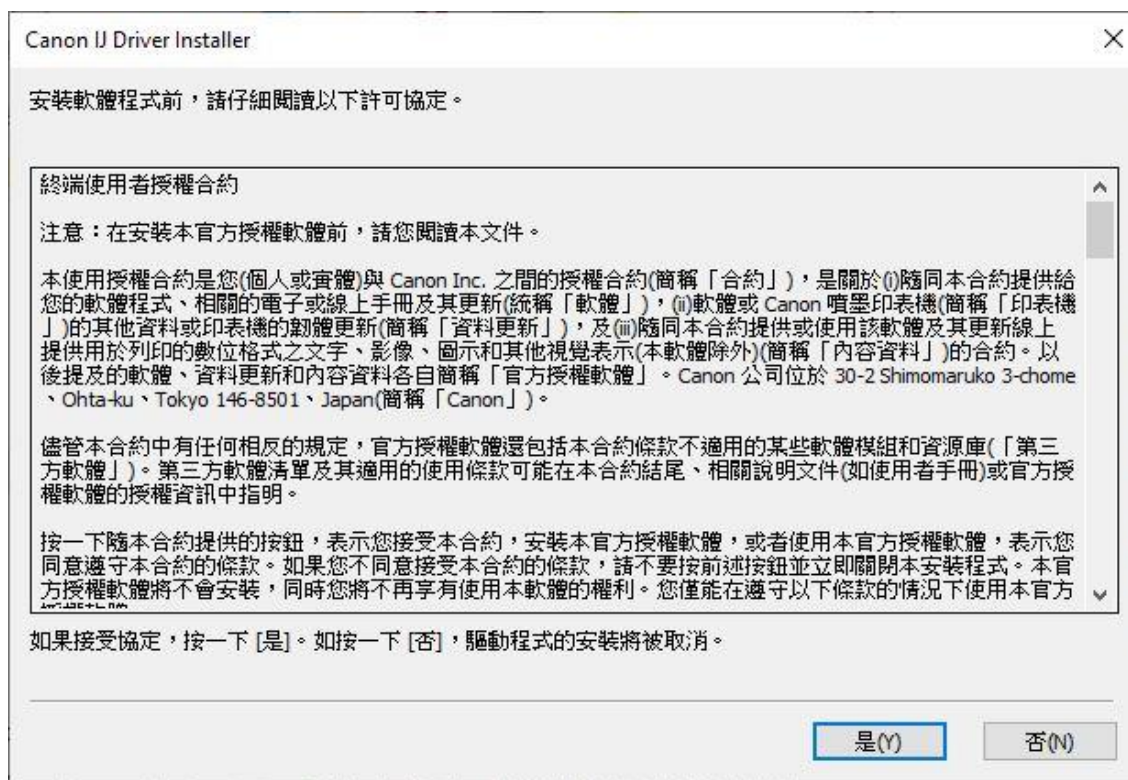

7. 如下圖所示，連接 USB 線，然後在清單中選擇連接方法為 USB 的打印機，按〔下一步〕
As the illustration below, connect the USB cable, then select the printer with USB connection method from the list, click [Next]

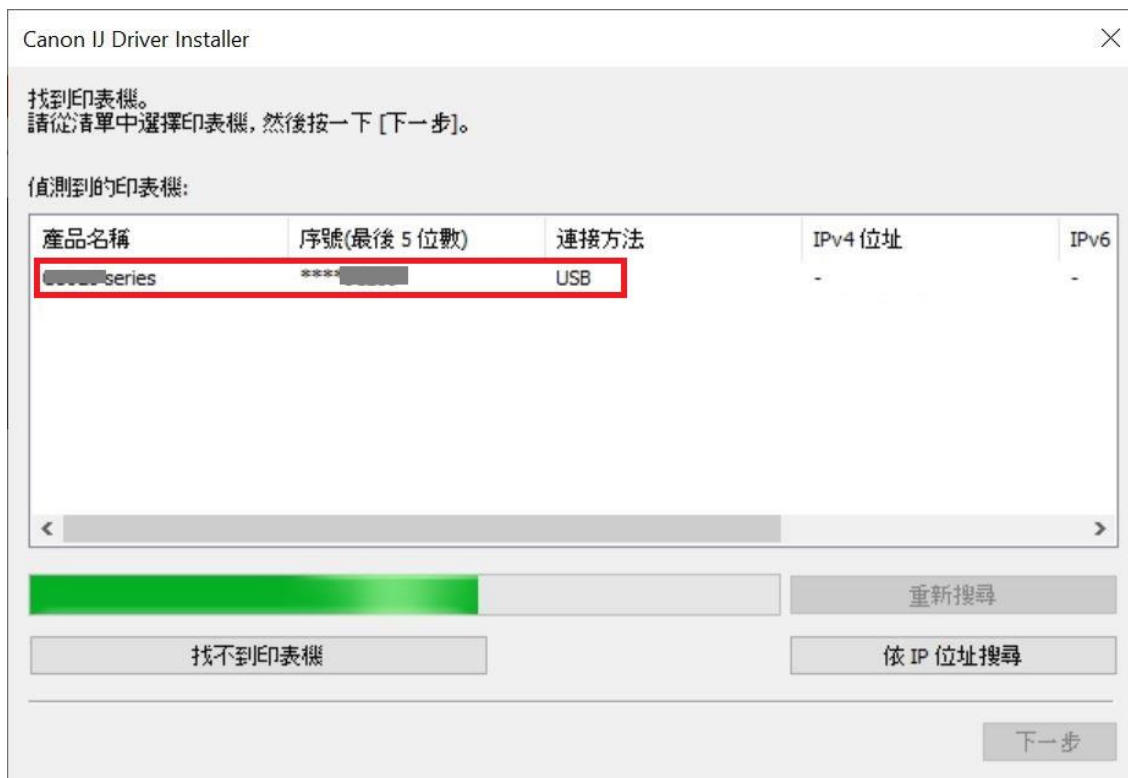
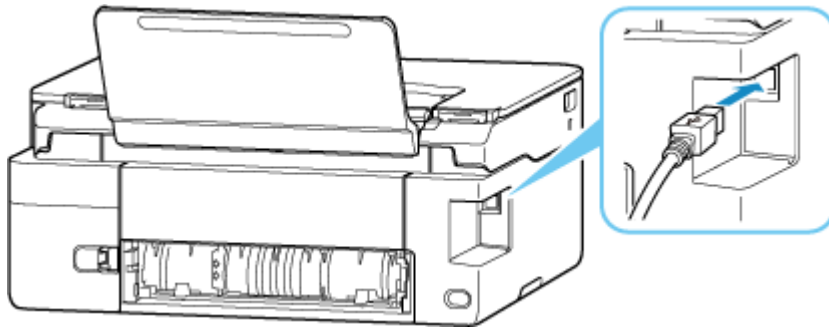

8. 正在安裝印表機驅動程式，請稍候
Installing the driver, please wait

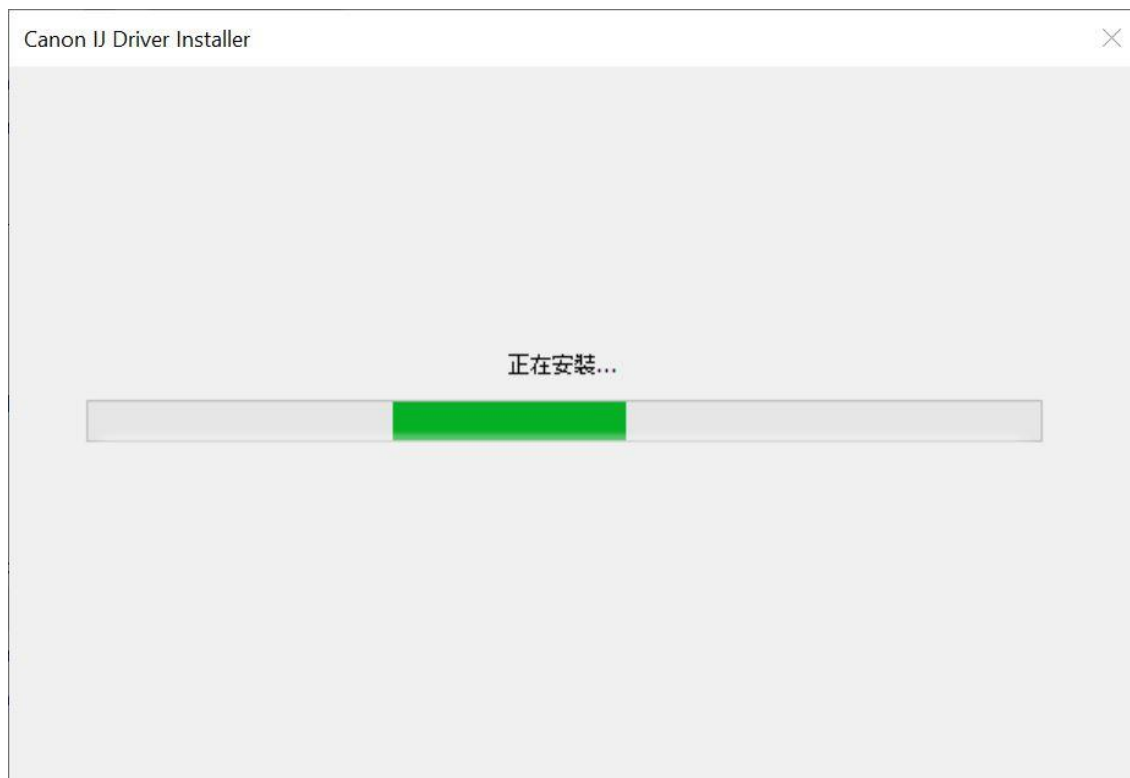

9. 安裝完成，按〔結束〕
Driver installation was completed; click [Finish]

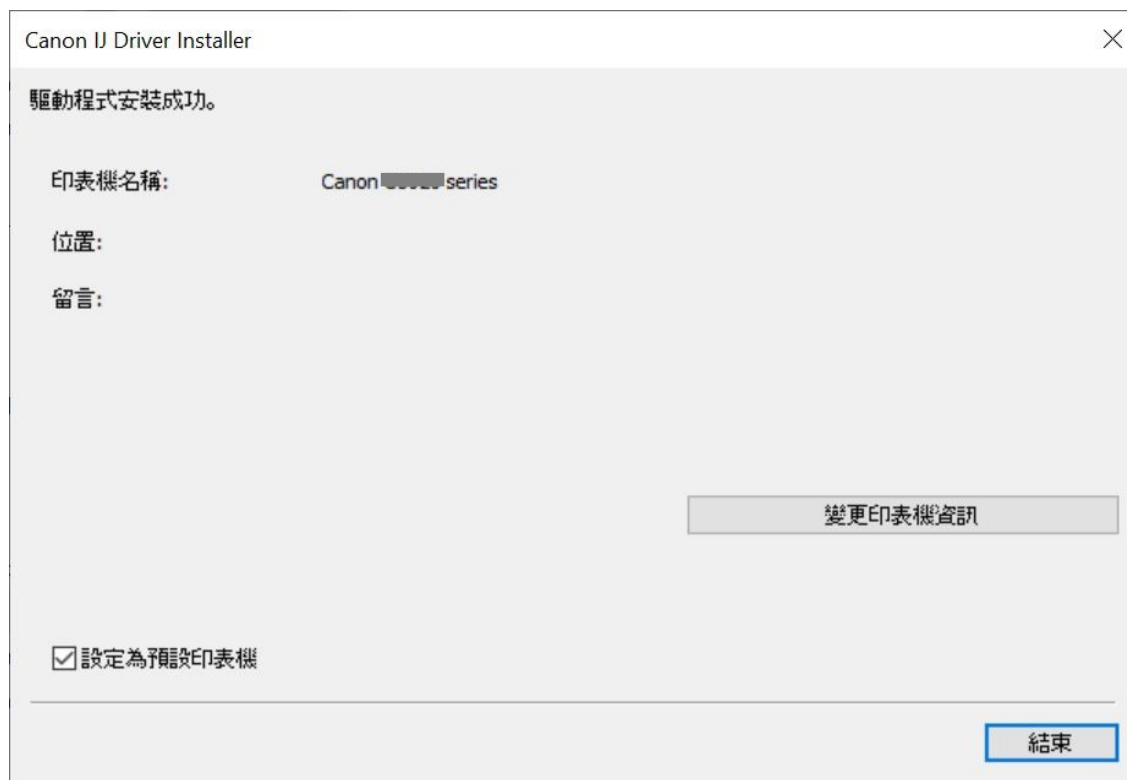

-完-
-End-