

在 Windows 以乙太網路連接安裝 G6070 驅動程式步驟 (以 Windows 10 作示範)  
G6070 printer driver Installation Guide for Windows via LAN (Windows 10 as example)

\*請開啟打印機並確保電腦已連接互聯網

\*Please turn on the printer and make sure computer already connected to the internet

連接印表機至網路路由器

Connect printer to router

1. 確保在開始有線連接設定之前，印表機已開啟。  
如果電源開啟，**電源(ON)**指示燈(A)將亮起或閃爍。  
Make sure printer is turned on before starting wired connection setup.  
If the power is on, the **ON** lamp (A) will be lit or flashing.

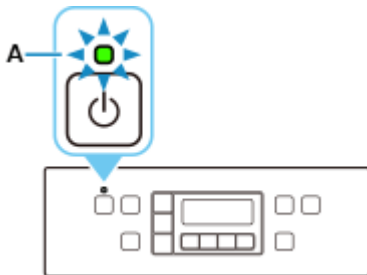

2. 按**設定(Setup)**按鈕(B)。  
Press the **Setup** button (B).

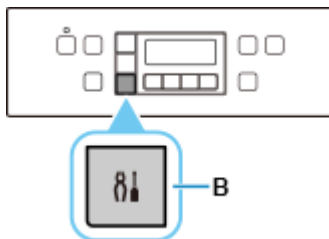

3. 需要乙太網路電纜線(另行出售)。  
You will need an Ethernet cable (sold separately).

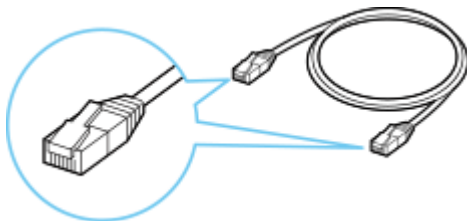

4. 從印表機後部左側取下連接埠的蓋(C)。

Remove the Cap (C) from the port located on the left side at the back of the printer.

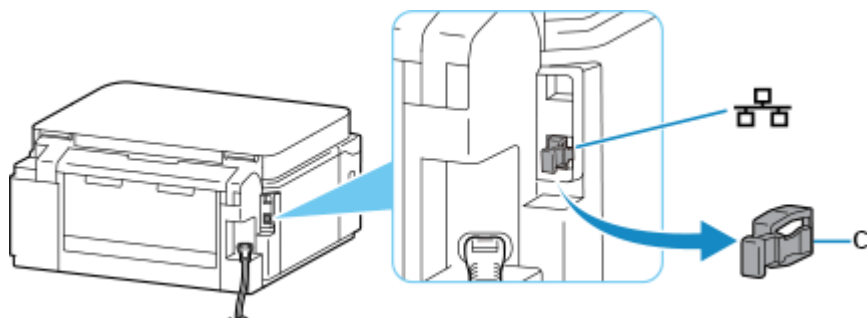

5. 使用乙太網路電纜線(D)連接印表機和網路裝置(路由器等)。

請勿連接到任何其他連接埠。

Connect the printer and a network device (router, etc.) with an Ethernet cable (D).

Do not connect to any other port.

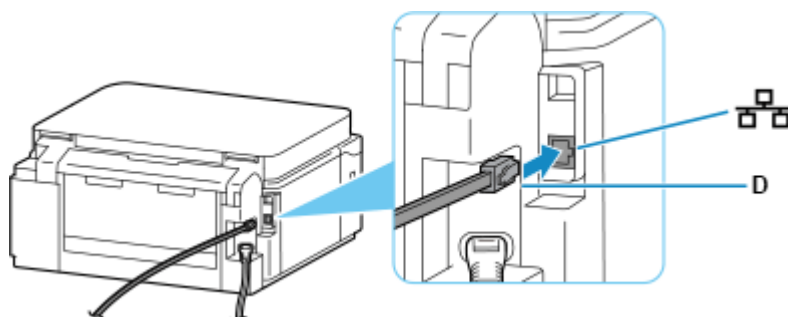

6. 使用◀或▶按鈕(E)選擇裝置設定(Device settings)，然後按OK按鈕。

Use the ◀ or ▶ button (E) to select Device settings and press the OK button.

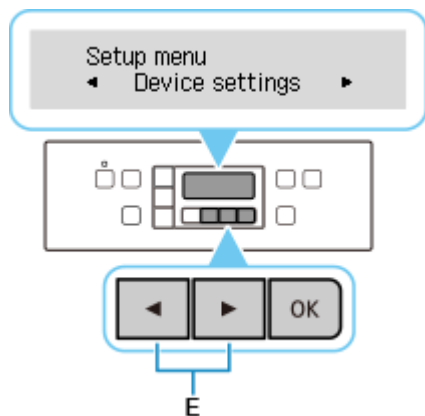

7. 選擇LAN設定(LAN settings)並按OK按鈕。

Select LAN settings and press the OK button.

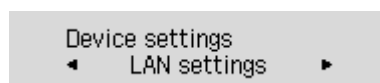

8. 選擇**有線 LAN(Wired LAN)**並按 **OK** 按鈕。

Select **Wired LAN** and press the **OK** button.

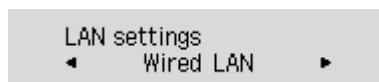

9. 選擇**啟用/禁用有線 LAN(Enab./dis. wired LAN)**並按 **OK** 按鈕。

Select **Enab./dis. wired LAN** and press the **OK** button.

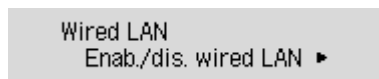

10. 選擇**啟用(Enable)**並按 **OK** 按鈕。

Select **Enable** and press the **OK** button.

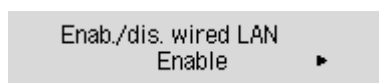

11. 如果顯示以下螢幕，請按 **OK** 按鈕。  
如果未顯示以下螢幕，請繼續執行下一步。

If the screen on the below appears, press the **OK** button.

If the following screen is not displayed, proceed to the next step.

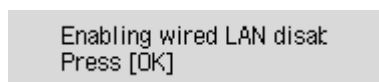

12. 按**影印(COPY)**按鈕(F)。

Press the **COPY** button (F).

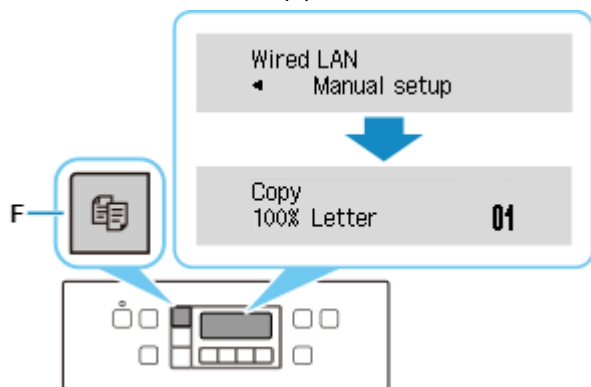

網路連接設定完成。

連接完成後，螢幕上會顯示 **LAN**。

The network connection setup is now complete.

When connection is complete, **LAN** appears on screen.

點擊以下連結下載有關之驅動程式:

[https://hk.canon/hong-kong/zh\\_HK/support/0101026703/1](https://hk.canon/hong-kong/zh_HK/support/0101026703/1)

Click below link to download printer driver:

<https://hk.canon/hong-kong/en/support/0101026703/1>

## 下載及安裝步驟

1. 按以上網頁內的“下載”，下載完成後開啟該檔案安裝

Click “Download” in the webpage above, and open the file after download completed

2. 按“下一步”

Click “Next”



3. 選擇“亞洲”，按“下一步”

Select “Asia”, and then click “Next”



4. 按“是”  
Click “Yes”

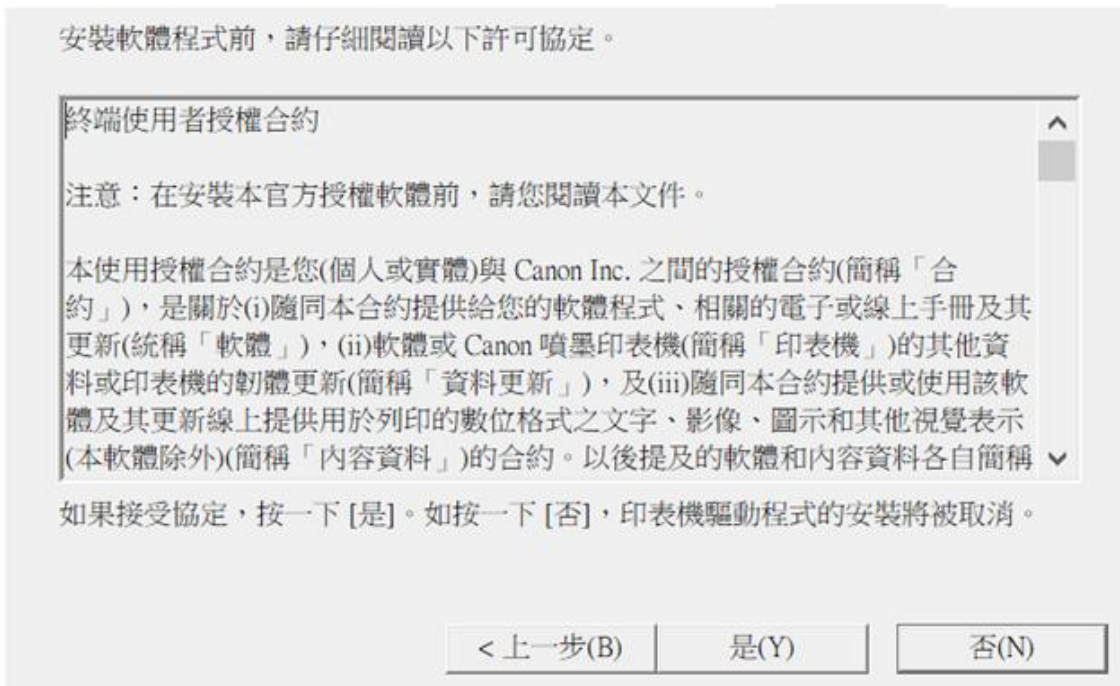

5. 選擇“透過無線 LAN 連接使用印表機 (W)”，按“下一步”  
Select “Use the printer with Wi-Fi connection”, and then click “Next”

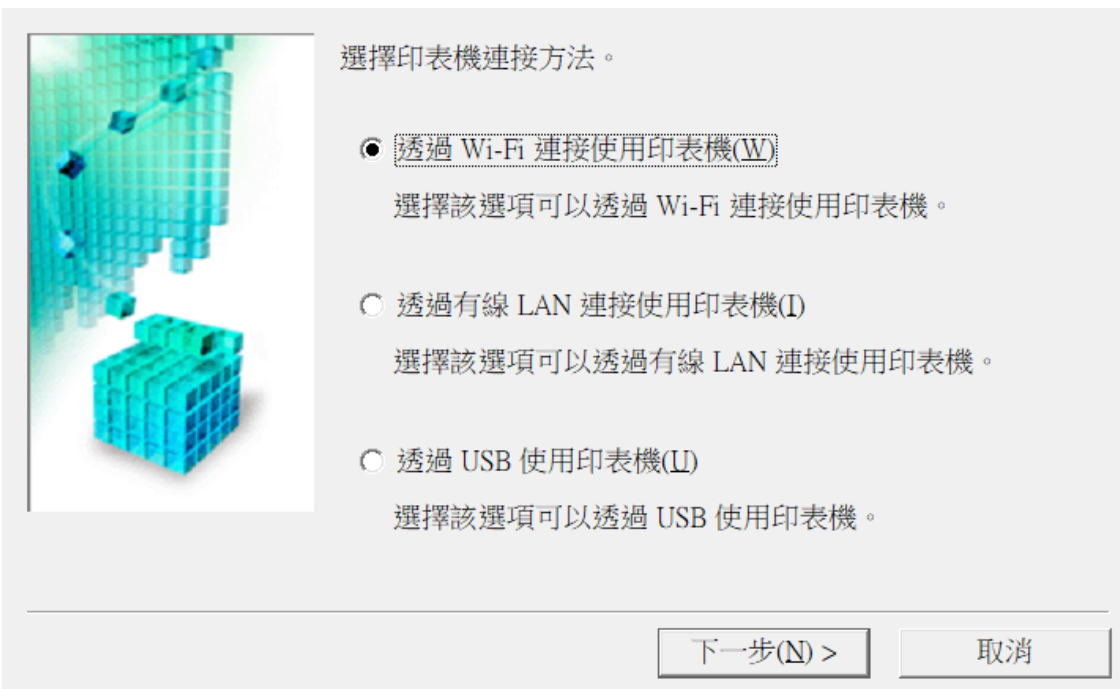

6. 點選“停用封鎖(R)”，按“下一步”

Select “Deactivate the block”, and then click “Next”



必須在 Windows 防火牆功能中停用對本軟體的封鎖。

停用封鎖(R)

下一步(N) >      取消

7. 選擇“自動搜尋(A)”，按“下一步”

Select “Auto search”, and then click “Next”



搜尋可以在網路上使用的印表機。  
通常情況下，請選擇 [自動搜尋]。

自動搜尋(A)

也可以透過指定在印表機上設定的 IP 位址來執行搜尋。

透過 IPv4 位址搜尋(I):  
[ . . . ]

透過 IPv6 位址搜尋(P):  
[ ]

下一步(N) >      取消

8. 選擇 “G6000 series” ，按 “下一步”

Select “G6000 series, and then click “Next”



9. 正在註冊印表機驅動程式，請稍候

Registering the driver, please wait a moment

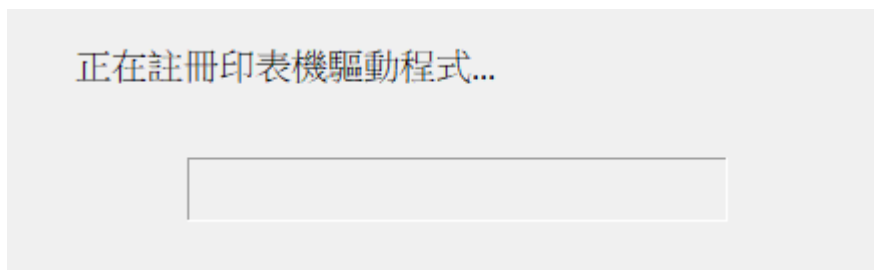

10. 安裝完成，按“完成”

Driver install completed, and then click “Finish”

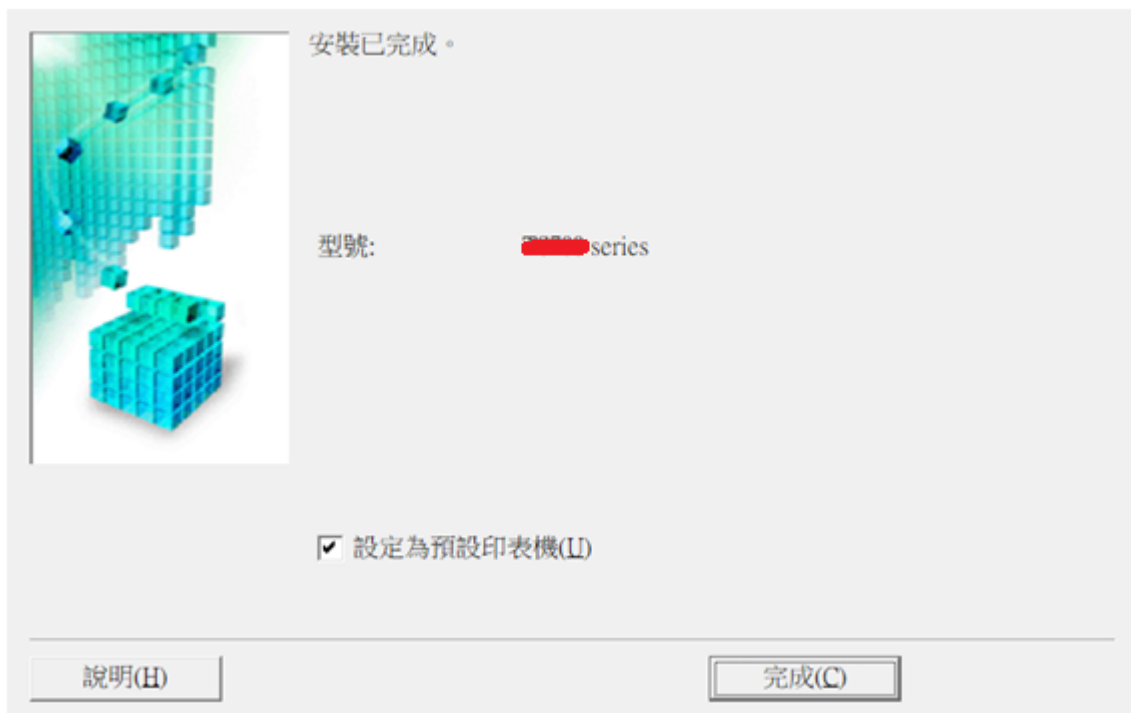

-完-

-End-