

**在 Mac OS X 以乙太網路方式安裝 G7070 驅動程式步驟**  
**G7070 printer driver Installation Guide for Mac OS X Via LAN connection**

1. 確保在開始有線連接設定之前，印表機已開啟。  
如果電源開啟，**電源(ON)**指示燈(A)將亮起或閃爍。  
Make sure printer is turned on before starting wired connection setup.  
If the power is on, the **ON** lamp (A) will be lit or flashing.

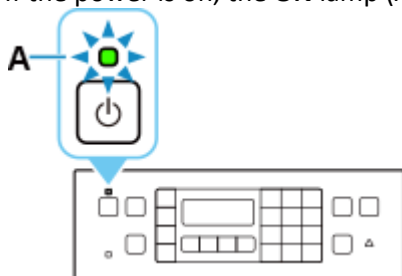

2. 按**設定(Setup)**按鈕(B)。  
Press the **Setup** button (B).

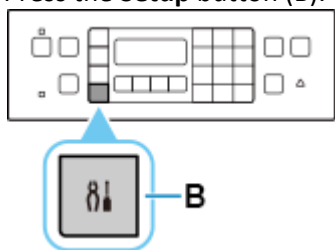

3. 需要乙太網路電纜線(另行出售)。  
You will need an Ethernet cable (sold separately).

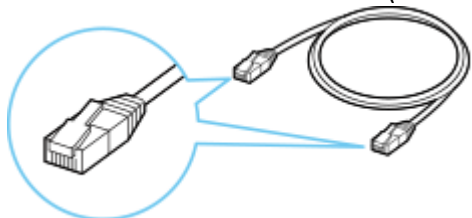

4. 從印表機後部左側取下連接埠的蓋(C)。  
Remove the Cap (C) from the port located on the left side at the back of the printer.

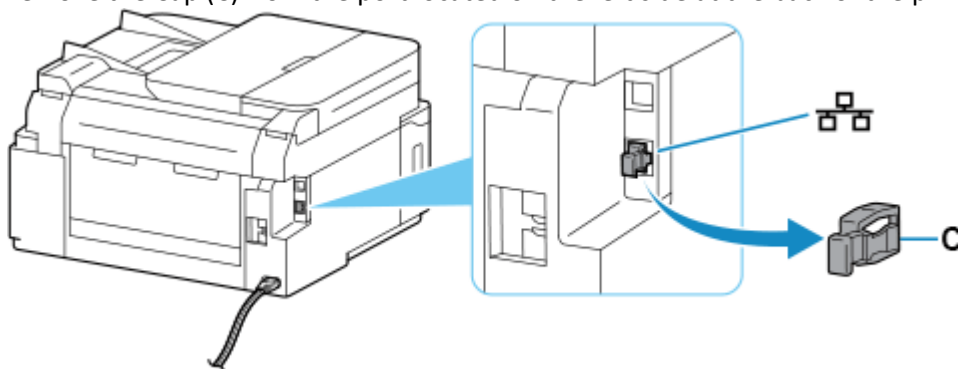

5. 使用乙太網路電纜線(D)連接印表機和網路裝置(路由器等)。  
請勿連接到任何其他連接埠。  
Connect the printer and a network device (router, etc.) with an Ethernet cable (D).  
Do not connect to any other port.

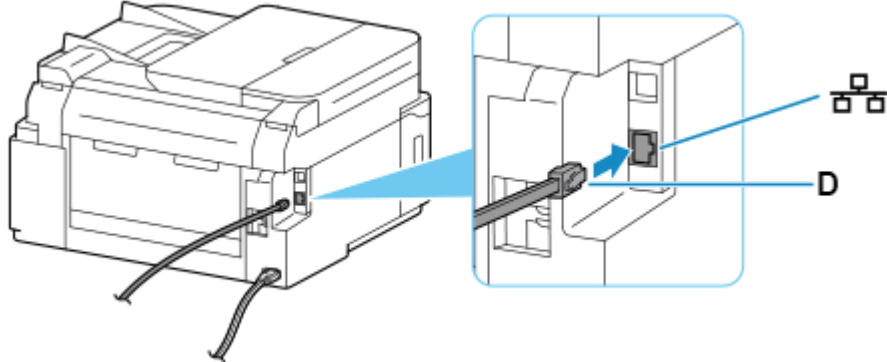

6. 使用 ◀ 或 ▶ 按鈕(E)選擇裝置設定(Device settings)，然後按 OK 按鈕。  
Use the ◀ or ▶ button (E) to select **Device settings** and press the **OK** button.

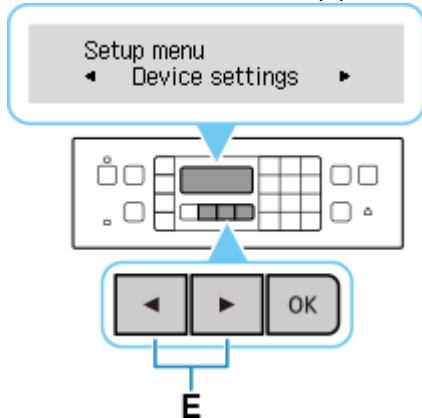

7. 選擇 LAN 設定(LAN settings)並按 OK 按鈕。  
Select **LAN settings** and press the **OK** button.

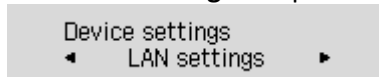

8. 選擇有線 LAN(Wired LAN)並按 OK 按鈕。  
Select **Wired LAN** and press the **OK** button.



9. 選擇啟用/禁用有線 LAN(Enab./dis. wired LAN)並按 OK 按鈕。  
Select **Enab./dis. wired LAN** and press the **OK** button.

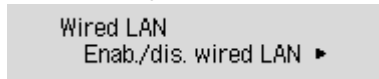

10. 選擇啟用(Enable)並按 OK 按鈕。  
Select **Enable** and press the **OK** button.

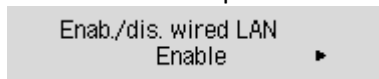

11. 如果顯示以下螢幕，請按 **OK** 按鈕。  
如果未顯示以下螢幕，請繼續執行下一步。  
If the screen on the below appears, press the **OK** button.  
If the following screen is not displayed, proceed to the next step.

Enabling wired LAN disak  
Press [OK]

12. 按**影印(COPY)**按鈕(F)。  
Press the **COPY** button (F).

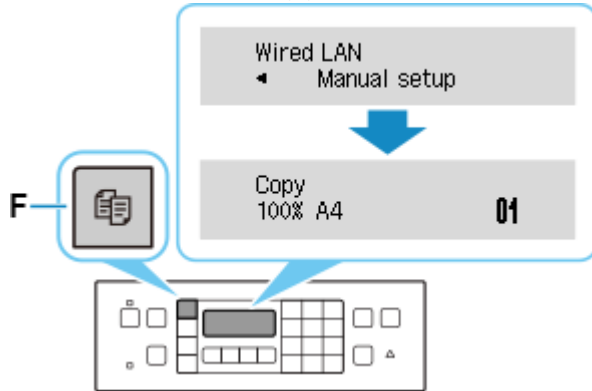

網路連接設定完成。

The network connection setup is now complete.

## Mac安裝步驟

### Mac installation procedure

安裝掃描軟件IJ Scan Utility Lite

IJ Scan Utility Lite installation procedure

13. 到以下佳能網站下載印表機的驅動程式  
[https://hk.canon/zh\\_HK/support/G7070/model](https://hk.canon/zh_HK/support/G7070/model)

Go to below Canon web and download the printer driver

<https://hk.canon/en/support/G7070/model>

14. 選擇並下載以下檔案  
Choose and download below files

- 掃描軟件 / Scanning software

**IJ Scan Utility Lite Ver.x.x.x (Mac)**

15. 下載完成後開啟該檔案，按「IJ Scan Utility Lite\_xxxxxx.pkg」  
Open file after download finished, press “IJ Scan Utility Lite\_xxxxxx.pkg”

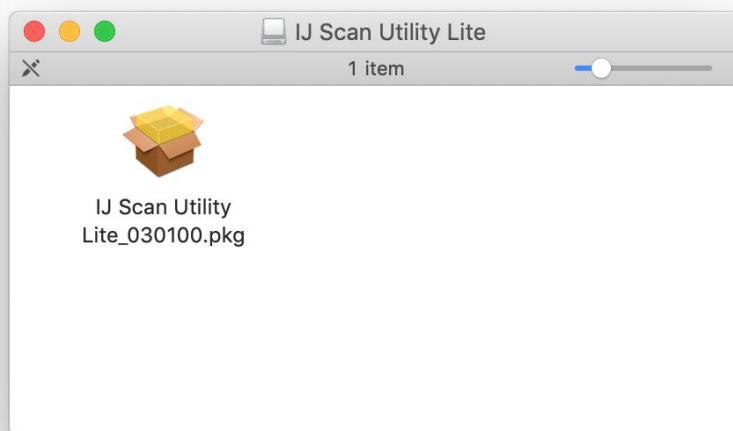

16. 按“繼續”  
Click “Continues”

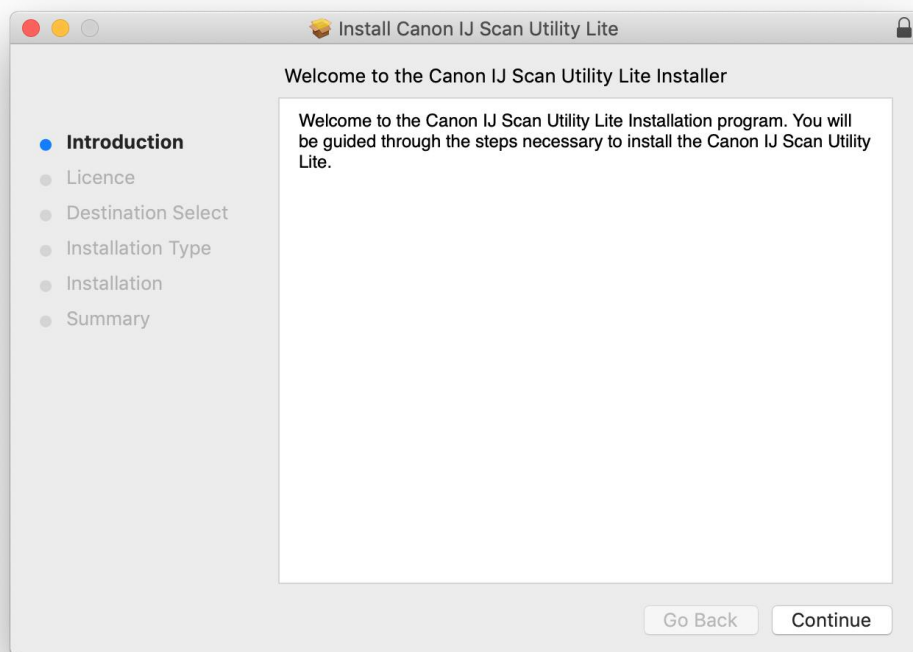

17. 按“繼續”  
Click “Continues”

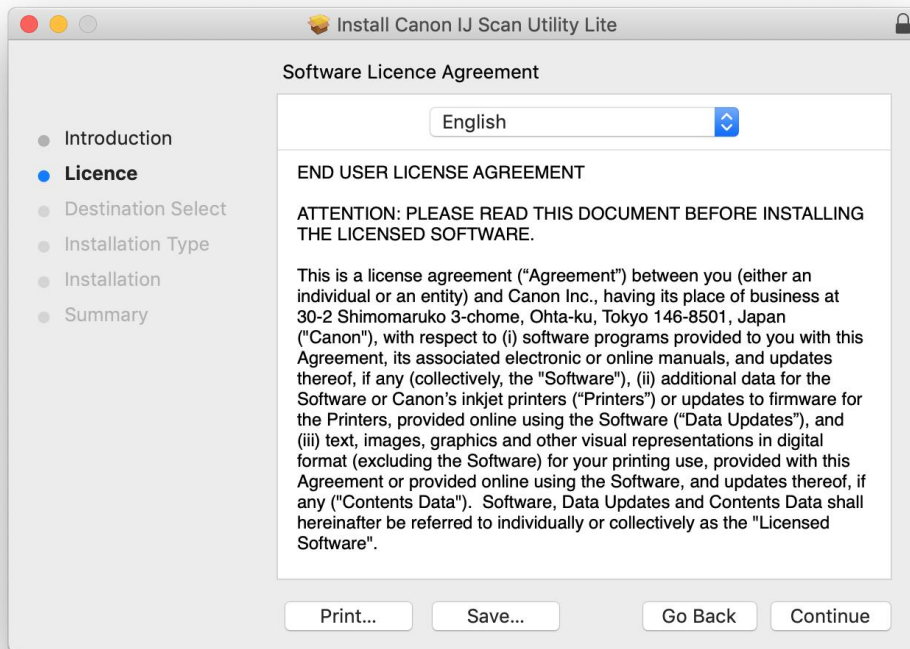

18. 按“同意”  
Click “Agree”

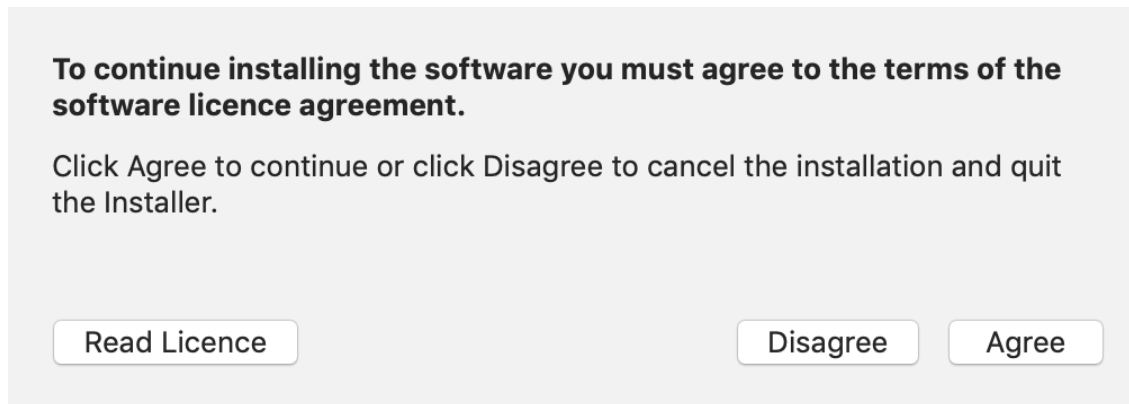

19. 按“安裝”  
Click “Install”

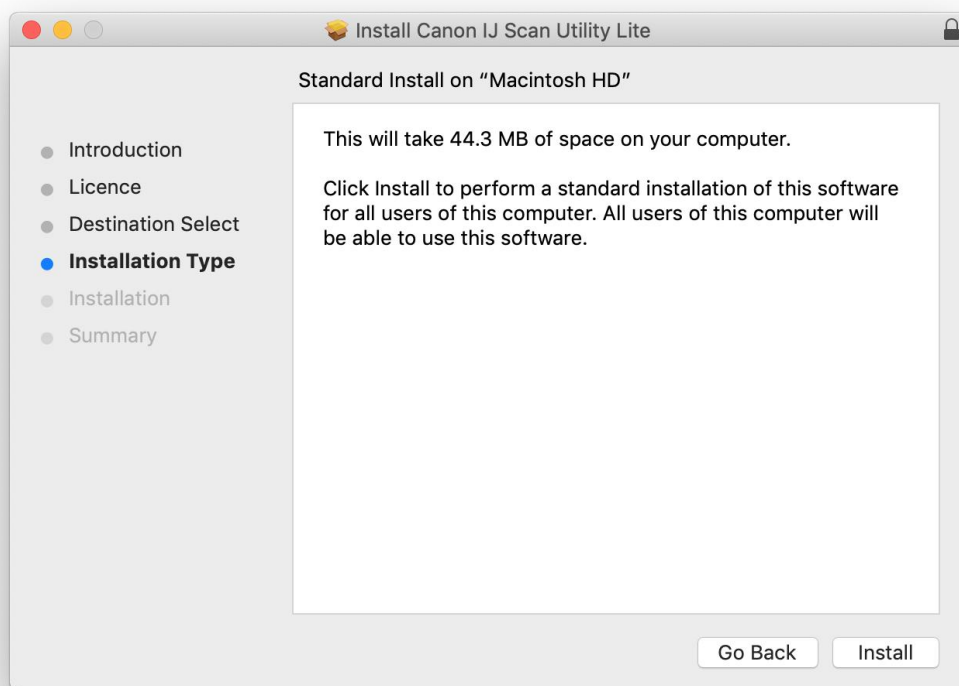

20. 如出現以下畫面，請輸入「登入名稱」和「密碼」  
If the following screen appears, please enter the “Username” and “Password”

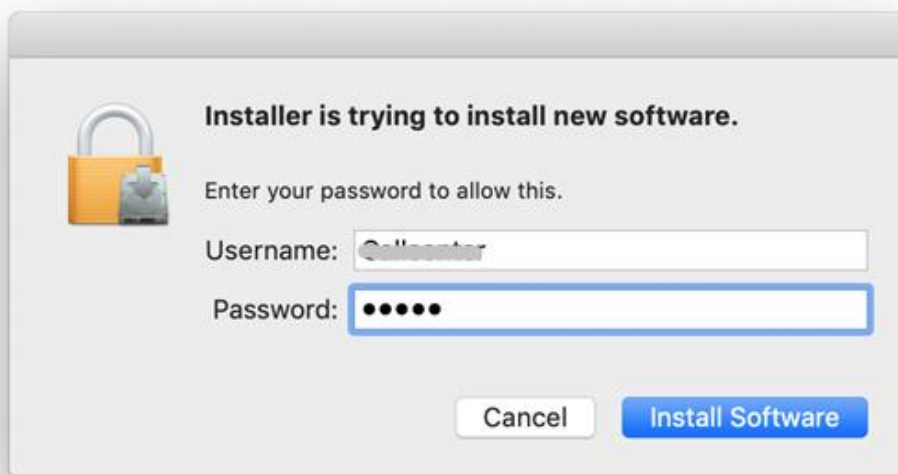

21. 掃描程式安裝完成，按“關閉”  
Software installation is completed. click “Close”

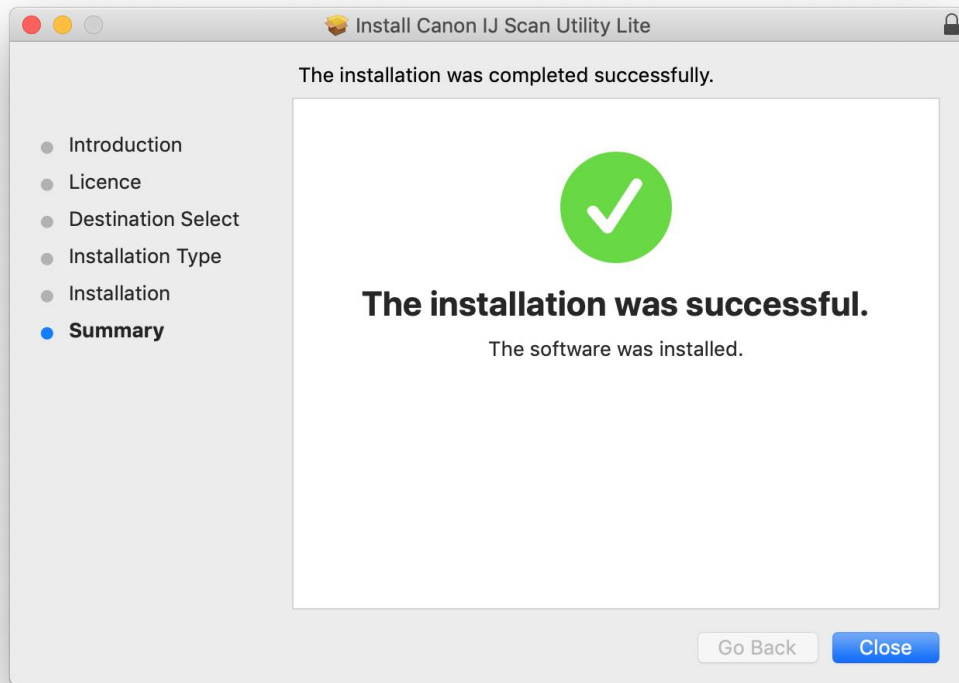

22. 在Mac電腦上，點選左上角的蘋果圖示，選擇系統偏好設定 > 印表機與掃描器，再點選左下角的「+」進入下圖的新增印表機視窗。選擇印表機「Canon G7000 Series」（種類為Bonjour多功能），確定「使用」為「Secure AirPrint」，然後按「加入」

On the Mac system, click the Apple icon on the top left corner, then choose “**System Preferences**” > “**Printers and Scanners**”. Click the “+” icon on the bottom left corner, then choose name as “Canon G7000 series” (Kind: Bonjour Multifunction), and make sure “Secure AirPrint” in “Use” column , and then click “Add”

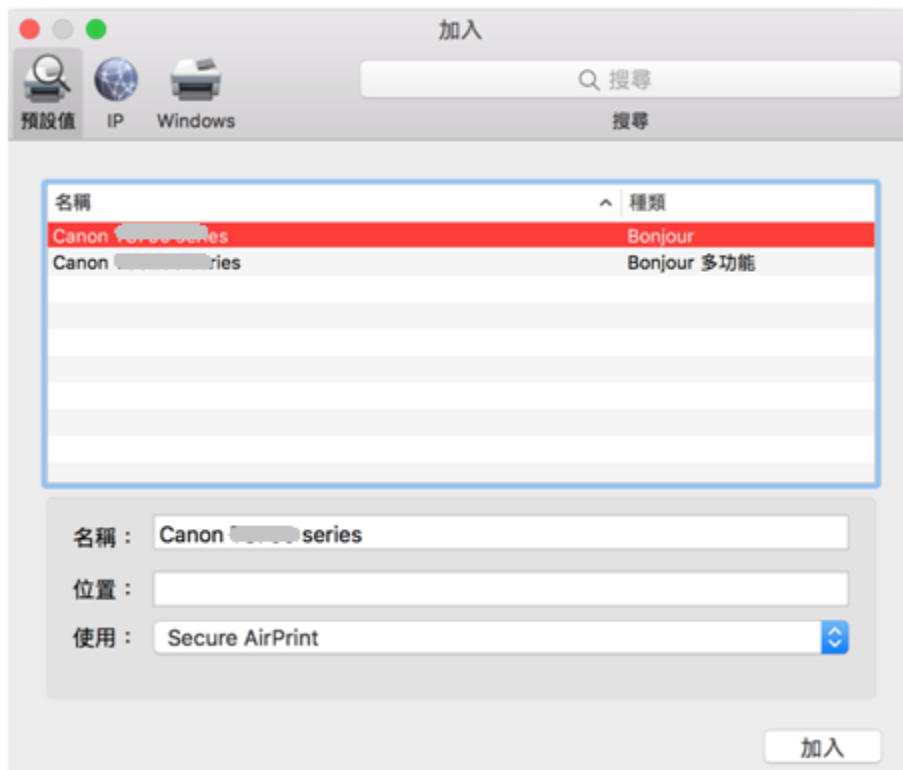
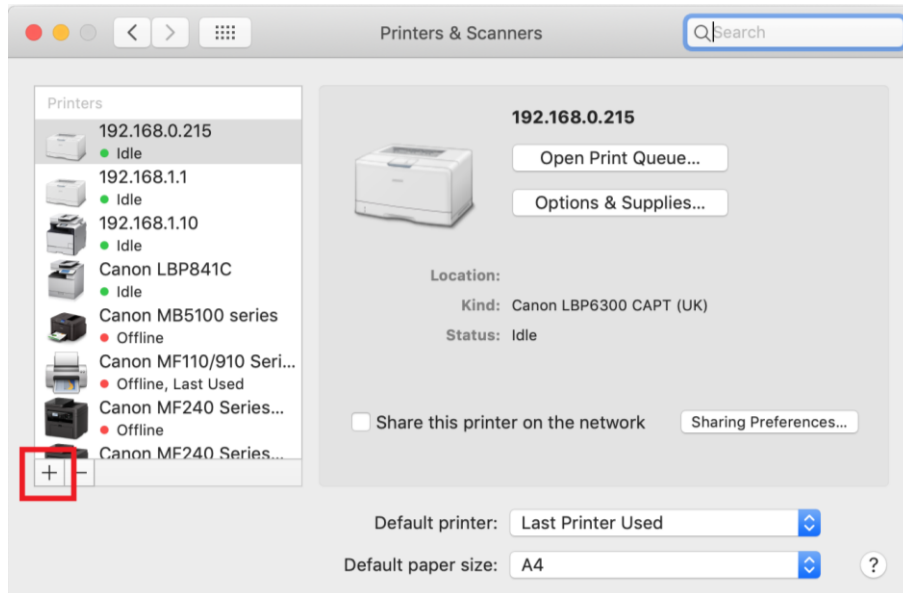

-完-  
-End-